

Date rev. Description

V 1.0

House 4,4,73781 München 9 4,4 ISO

Sheet 1

Drawing 3D

Scale

Material 4,4x135

Date 21.11.2023

Drawer K.K.

File 4,4,73781 München 9 4,4 ISO 3D.dwg

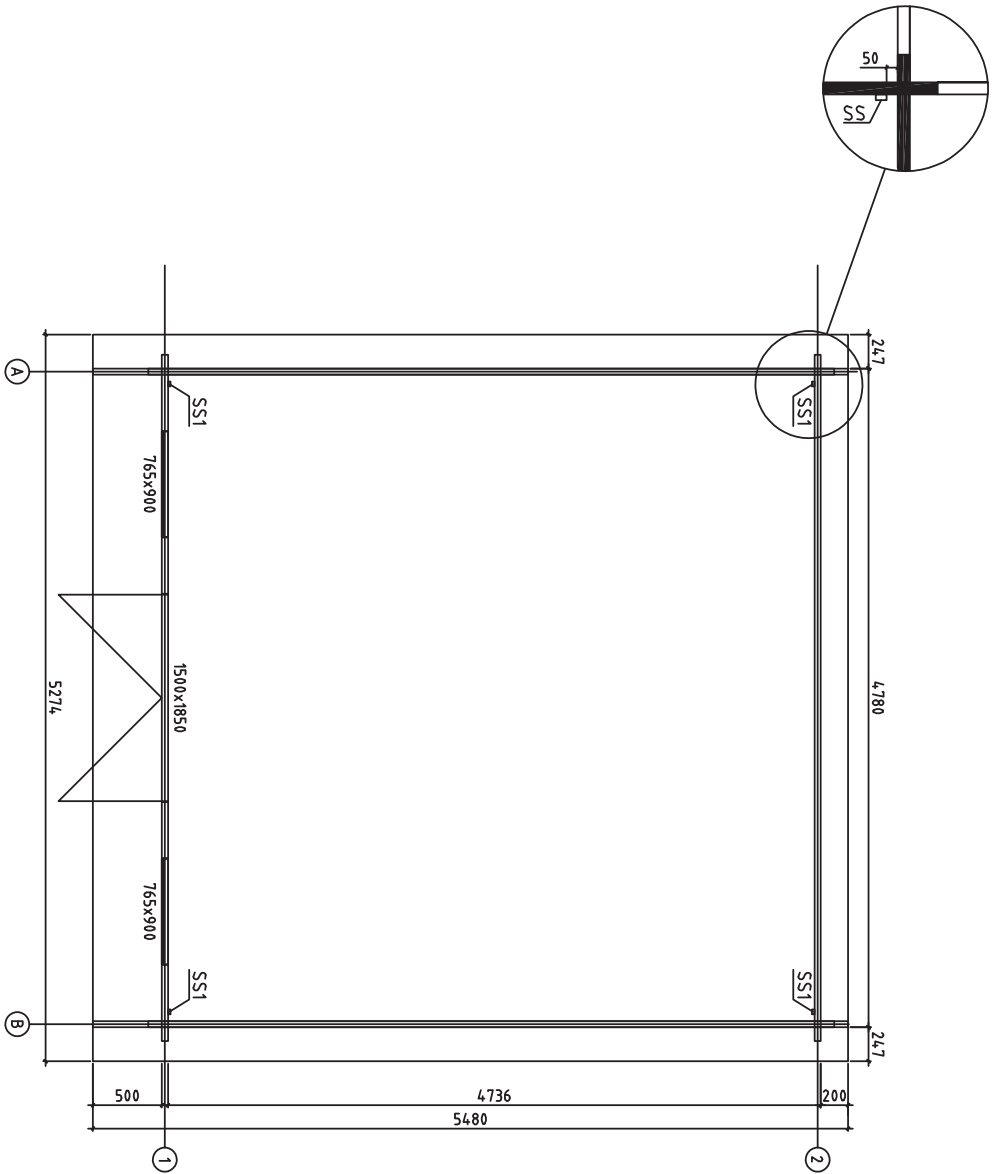

Kood	4473781 München 9 44 ISO	Leht	2
Joonis	Plan	Muutkava	1:50
Materjal	44x135	Kuup	01.12.2023
Joonistas	K.K.	File	4473781 München 9 44 ISO.dwg

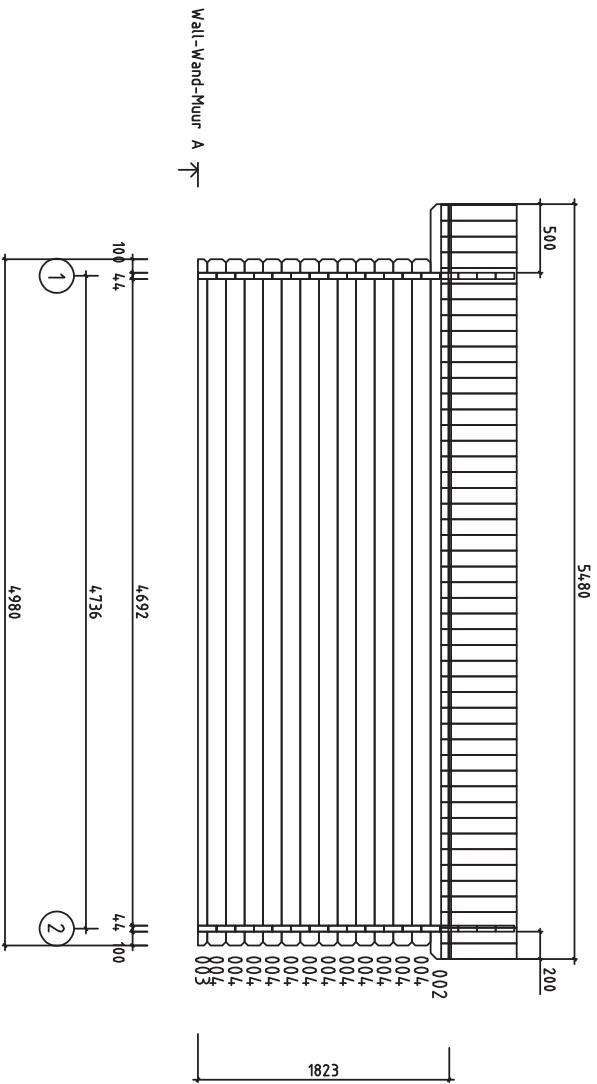

Koed	4473781 München 9 4,4 ISO	Leht	3
Joonis	WALL-WAND-MUUR A	Mohtava	1:50
Materjal	4,4 x 13,5	Kuup	01.12.2023
Joonestas	K.K.	File	4473781 München 9 4,4 ISO.dwg

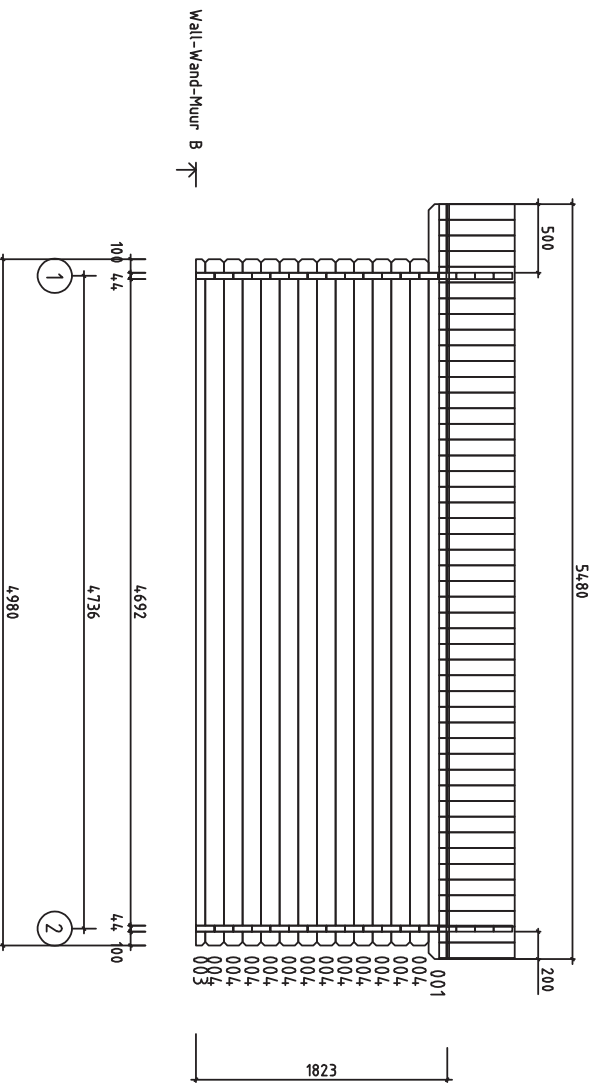



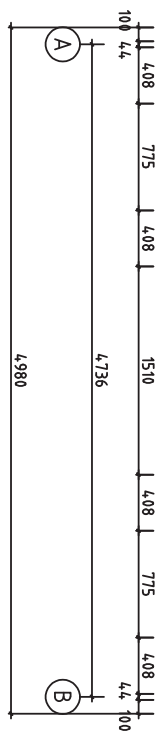
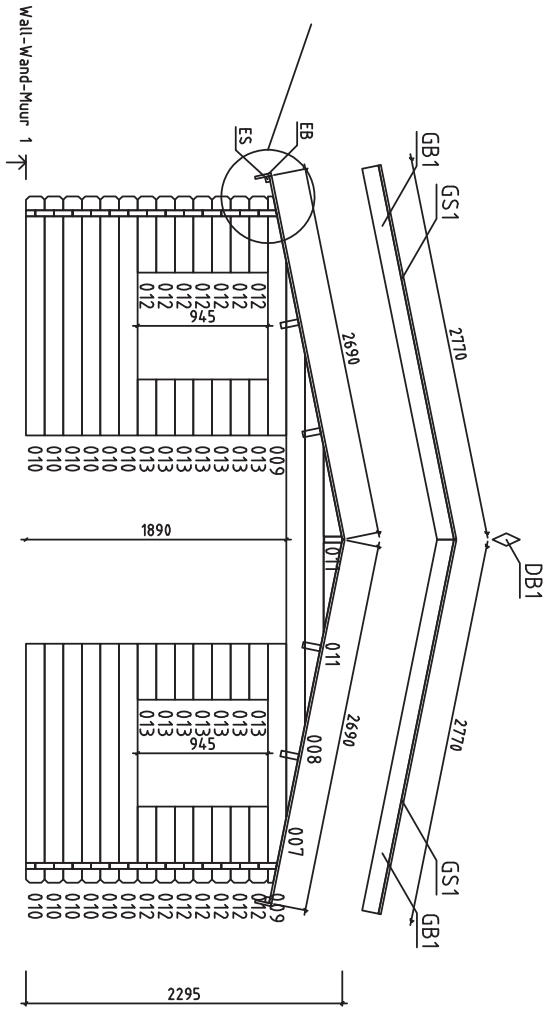
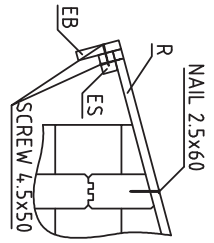



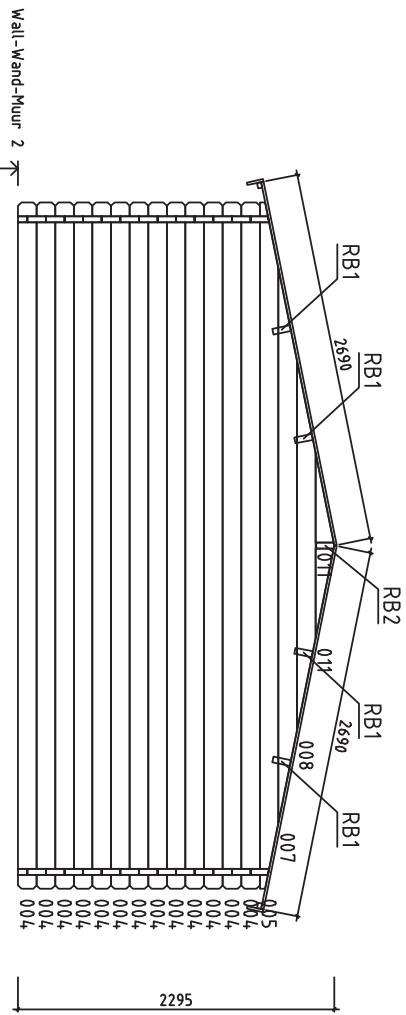



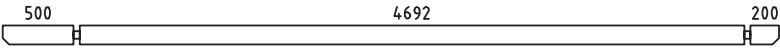
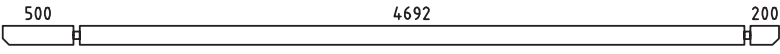
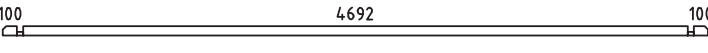
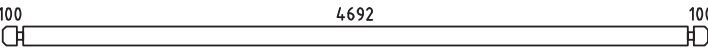
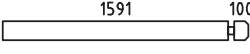

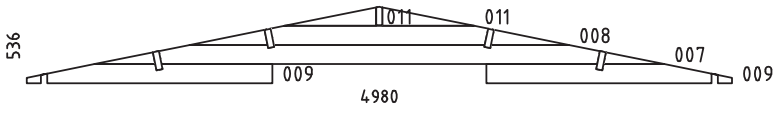
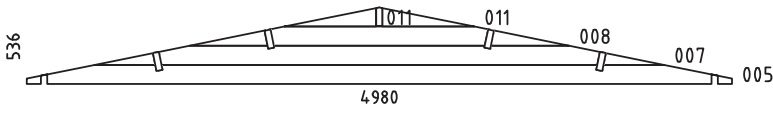
Koed	4.4.73781 München 9 4.4. ISO	Leht	4
Joonis	WALL - WAND - MUUR B	Mohtava	1:50
Materjal	4.4.x13.5	Kuup	01.12.2023
Joonistas	K.K.	File	4.4.73781 München 9 4.4. ISO.dwg

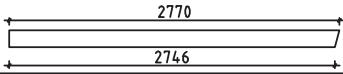

Koed	4,4,73781 München 9 4,4, ISO	Leht	5
Joonis	WALL-WAND-MUUR 1	Moottava	1:50
Materjal	4,4, x13,5	Kuup	01.12.2023
Joonestas	K.K.	File	4,4,73781 München 9 4,4, ISO.dwg



Koed	4.4.73781 München 9 4.4. ISO	Leht	6
Joonis	WALL-WAND-MUUR 2	Mohtava	1:50
Materjal	4.4.x13.5	Kuup	01.12.2023
Joonestas	K.K.	File	4.4.73781 München 9 4.4. ISO.dwg

Pos	Specification-Bestimmung-Omschrijving	Pcs	Profile (mm)	L (mm)
001	 500 4692 200	1	44x135	5480
002	 500 4692 200	1	44x135	5480
003	 100 4692 100	2	44x68	4980
004	 100 4692 100	37	44x135	4980
006	100 4836 SPARE BEAM-ERZATZBOHLE-VOORRAADPLANK	1	44x135	4980
010	 1591 100	12	44x135	1735
012	 408 100	14	44x135	552
013	 408	14	44x135	408
W1-1	 536 4980 009 007 008 011 011 009	1	44x536	4980
W2-1	 536 4980 005 007 008 011 011 005	1	44x536	4980
HB	HIT BLOCK-SCHLAGHÖLZER-BLAZENPLANK 	2	44x135	300
RB1	500 ROOFBEAMS-DACHBALKEN-DAKBALK 4692 200	4	43x140	5480
RB2	500 ROOFBEAMS-DACHBALKEN-DAKBALK 4692 200	1	43x140	5480
R1	ROOFBOARD-DACHBRETT-DAKPLANK  or-oder-of	127+2 98+2	18x88 18x114	2690
GB1	GABLE BOARD-GIEBELBLENDE-GEVELPLANK  2770 2746	4	18x120	2770
GS1	ROOF FELT FILLET-GIEBELLEISTE-GEVELLIJST 	4	18x70	2770
EB1	EAVE BOARD-TRAUFBRETT-AFDEKPLANK 	4	18x90	2740
ES1	EAVE SLAT-TRAUFLIISTE-AFDEKLIJST 	4	30x40	2740
DB1	DIAMOND-RAUTE-DIAMANT 	2	18x90	200
SS1	STORM SLAT-STURMLEISTE-STORMLIJST 	4	18x35	1750
	SCREWS-SCHRAUBEN-SCHROEF FOR-FÜR-VOOR SS1 	12	ø6.0	50
	WASHER-SCHEIBE-SCHIJF FOR-FÜR-VOOR SS1 	12	ø6.0	18
	NAIL-NAGEL-NAGEL FOR-FÜR-VOOR R1 	530	ø2.5	60
Kood	4473781 München 9 44 ISO Materjal	File	4473781 München 9 44 ISO.dwg	Leht 7

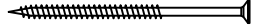
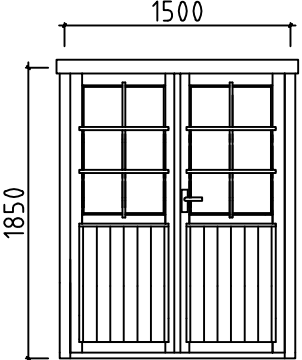
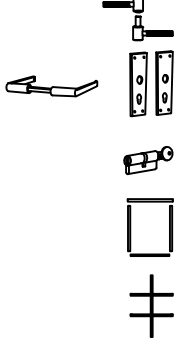
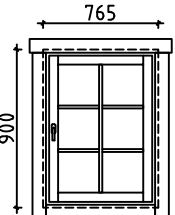
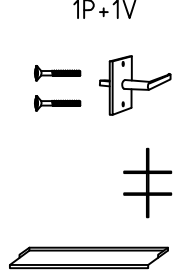
Pos	Specification-Bestimmung-Omschrijving	Pcs	Profile (mm)	L (mm)
	SCREWS-SCHRAUBEN-SCHROEF FOR-FÜR-VOOR GB1, GS1, EB1, ES1, DB1 	90	ø4.5	50
	SCREWS-SCHRAUBEN-SCHROEF FOR-FÜR-VOOR RB1, RB2 	10	ø6.0	160
	DOUBLEDOR-DOPPELTÜR-DUBBELE DEUR (right-rechts-rechts) AST __ISO__PL p.p.  	1	1500	1850
	WINDOW-FENSTER-VENSTER (1x right-rechts-rechts; 1x left-links-links) AST_PRE  	2	765	900